



DUFOUR

31

you are on board a Dufour 31

a boat which turns your dreams into realities

A 31 foot yacht which is easy to sail singlehanded, seaworthy enough to go around the world, yet large enough to accommodate six comfortably on board is not an impossible dream : it is the DUFOUR 31.

Many people think that she is the best of the DUFOUR range.

There is no doubt that the three most important objectives of a modern design are fulfilled : aesthetics, performance and comfort.

To these can be added a fourth quality which is not so frequently found ; she is wonderful to live on.

This habitability comes from the overall feeling of space and light in the accommodation.

The harmonious proportions of the interior create an atmosphere of warmth and solidarity which is completed by the superb quality of the warm looking mahogany woodwork.

The DUFOUR 31 offers happy contentment by fulfilling all your dreams.

ocean cruising or weekend cruising ?

Your DUFOUR is built to cross the oceans but she likes to explore the coast ; and should you be in love with solitude, you can choose the shallow draft version which allows you to find those hideways in the Caribbean, Brittany or Scotland's west coast. At sea you will appreciate the seaworthy hull with its generous freeboard and powerful lines designed for speed.

The large foretriangle of the modern rig means that she will point high when closehauled and the husky mainsheet traveller enables the helmsman to achieve a perfectly balanced helm at all times.

The spacious deck makes sail handling secure.

You will appreciate the strong Goyot and Lewmar deck fittings, robust stanchions, double lifelines, the halyard pit at the mastfoot, the moulded in liferaft support, the reefing winch and many other details which we have thought of for safety at sea.

details which make the difference

Design superiority comes from practical sailing experience coupled with quality construction.

The result of our long experience of building seagoing pleasure yachts can be seen everywhere.

You will appreciate features like the gimballed cooker and sink unit with its standard galley strap, the external gas locker with an outboard drain, the special design of the companionway steps, the icebox with access from the galley and the cockpit, the inbuilt dust collector in the cabin sole, the slot in the chart table to prevent creasing the charts, the inbuilt radio aerial, the backrests fixed to the locker doors, the vanity mirror angled in just the right way.

robust equipment for safe sailing

One does not play with the sea. Everything on the DUFOUR 31 has been designed for safe and pleasant cruising. The cockpit is large and the specially designed coamings are comfortable whether you are sitting out when sailing to windward or basking in the sun downwind.

The galley is excellently equipped and includes the cutlery and the high quality melamine tableware. Everywhere in the accommodation you will find lockers and stowage spaces which are always perfectly dry, this being the advantage of the one-piece inner moulding.

Bilge water is collected in a real bilge sump above the keel so no more cooking with your feet in water.

All the rigging is grounded, all hull fittings are protected by valves and a fire extinguisher is provided.

When it comes to safety, DUFOUR leaves nothing to chance.

the DUFOUR 31 ?

A strong boat for years of happy cruising.

Buy one and prove it to yourself.

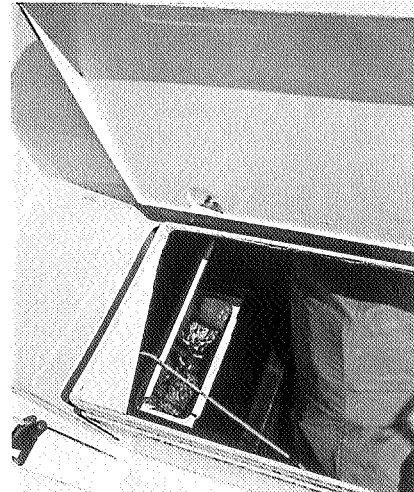
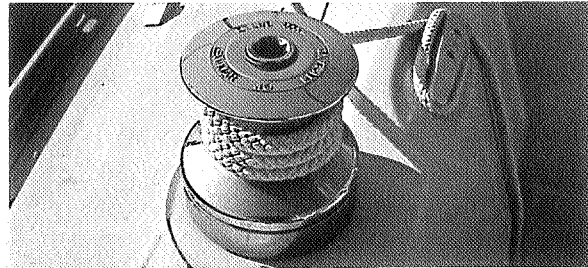
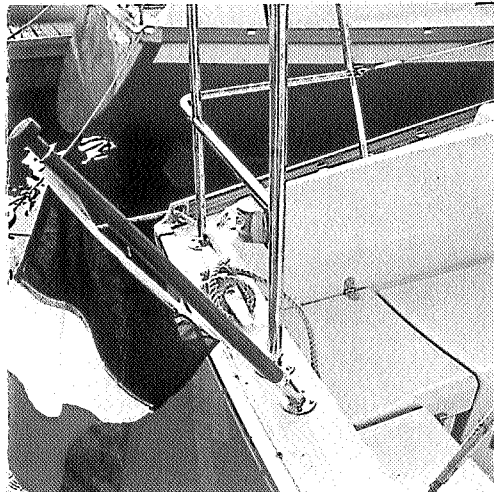
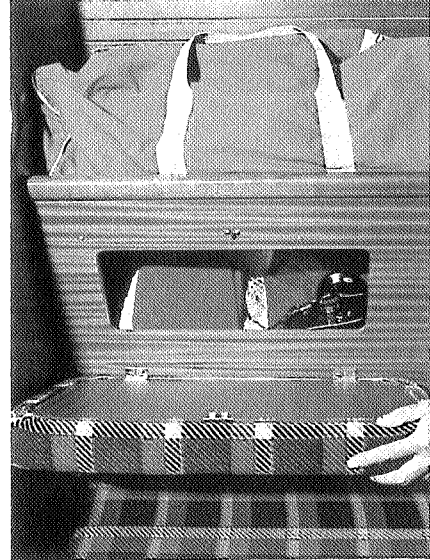
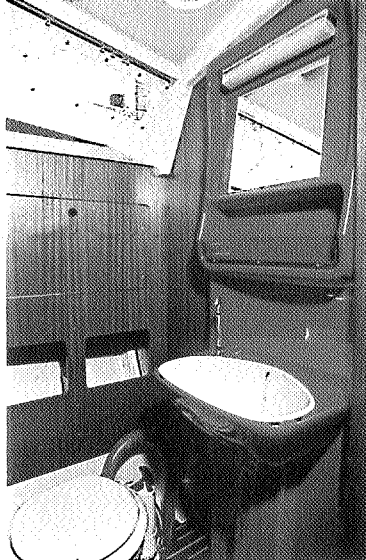
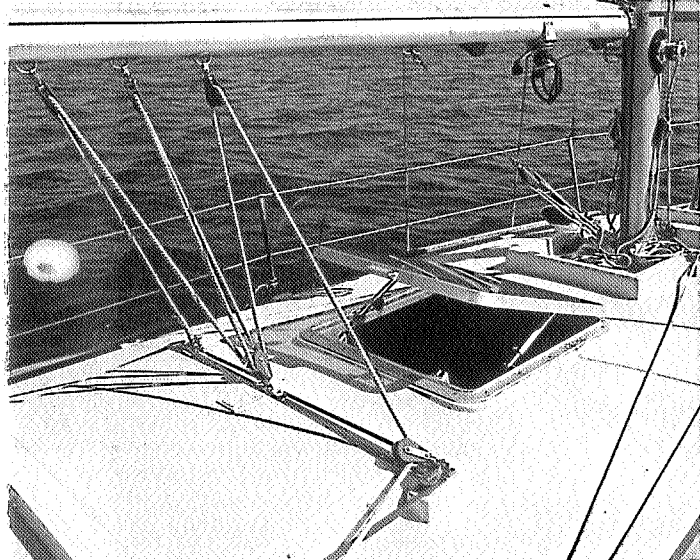
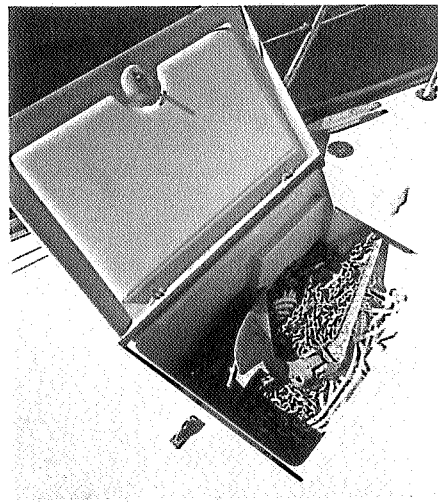
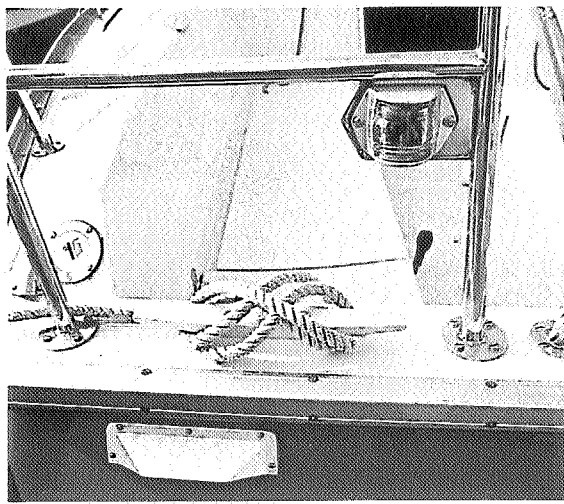
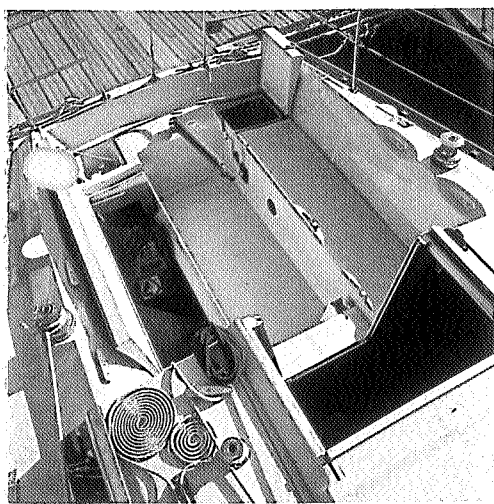
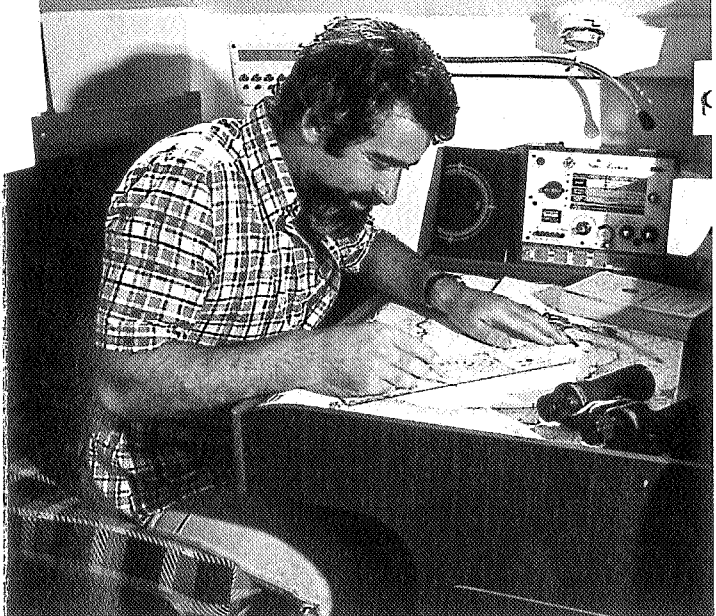



Purchasing a sailing boat is a decision which must be taken seriously... just like the sea.

The yacht you are going to choose must be a good sailor. She must also be safe and comfortable in any weather.

There is only one answer to these objectives - quality. This we understood from the beginning with the SYLPHE and ARPEGE.

**Because every step of the conception is controlled (from the designer's first draft to the industrial production) :
Because we have created a factory second to none.
Because we are assisted by competent and serious dealers
we can guarantee the DUFOR QUALITY.**

For you it is the guarantee of lasting pleasure and a sure investment.



MICHEL DUFOR

DUFOUR 31

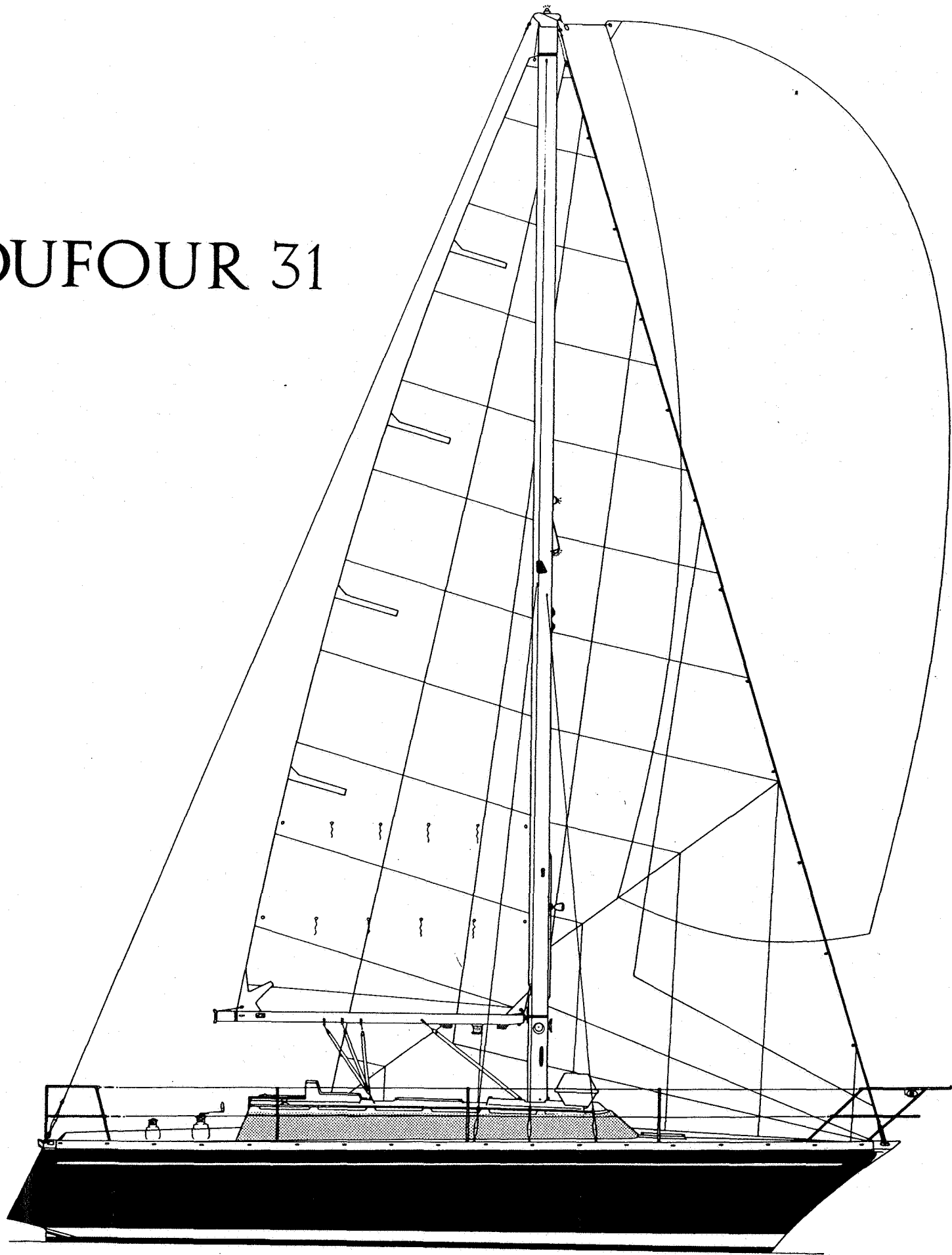

MICHEL DUFOUR S.A.

Zone Industrielle de PERIGNY. 17001 LA ROCHELLE. Tel: 53.16.46.

